



**Technical and Test Institute
for Construction Prague**
Prosecká 811/76a
190 00 Prague
Czech Republic
eota@tzus.cz

Member of



www.eota.eu

European Technical Assessment

**ETA 13/0951
of 29/08/2014**

(English language translation, the original version in Czech language)

**Technical Assessment Body issuing the
ETA and designated according to Article
29 of the Regulation (EU) No 305/2011**

Technical and Test Institute
for Construction Prague

Trade name of the construction product

BRAVOLL[®] PTH-X, PTH-EX

**Product family to which the construction
product belongs**

Product area code: 33
Plastic anchors for fixing of external
thermal insulation composite systems with
rendering in concrete and masonry

Manufacturer

ITW Construction Products CZ s.r.o.
Sídliště č.p. 696
394 68 Žirovnice
Czech Republic

Manufacturing plant(s)

ITW Construction Products CZ s.r.o.

**This European Technical Assessment
contains**

17 pages including 13 Annexes which form
an integral part of this assessment.

**This European Technical Assessment is
issued in accordance with regulation
(EU) No 305/2011, on the basis of**

ETAG 014, edition 2011, used as European
Assessment Document (EAD) according to
Article 66 Paragraph 3 of regulation (EU)
No 305/2011.

This version replaces

ETA 13/0951 issued on 25/06/2013

Translations of this European Technical Assessment in other languages shall fully correspond to the original issued document and should be identified as such.

Communication of this European Technical Assessment, including transmission by electronic means, shall be in full (excepted the confidential Annex(es) referred to above). However, partial reproduction may be made, with the written consent of the issuing Technical Assessment Body - Technical and Test Institute for Construction Prague. Any partial reproduction has to be identified as such.

1. Technical description of the product

The nailed-in plastic anchors BRAVOLL® PTH-X, PTH-EX consist of plastic sleeve with a plate made for fixing the thermal insulation system (ETICS) and an expansion nail.

The sleeve anchor BRAVOLL® PTH-X is made of polypropylene and the accompanying specific expansion nail is made of reinforced polyamide. The sleeve anchor BRAVOLL® PTH-EX is made of polypropylene and the accompanying specific expansion nail is made of steel strength class 5.8. The head of the expansion nail has reinforced polyamide coating.

Both types of anchors have deformation zone on their sleeve. This deformation zone is for easier assembly during countersinking of the anchor plate into an insulation.

The anchors BRAVOLL® PTH-EX may additionally be combined with the additive anchor plates BRAVOLL® IT PTH 100 and IT PTH 140, which are shown in Annex A5.

The anchor is installed in drilled hole by hammering in the expansion nail.

The illustration and the description of the product are given in Annex A.

2. Specification of the intended use in accordance with the applicable EAD

The performances given in Section 3 are only valid if the anchor is used in compliance with the specifications and conditions given in Annex B.

The provisions made in this European Technical Assessment are based on an assumed working life of the anchor of 25 years. The indications given on the working life cannot be interpreted as a guarantee given by the producer, but are to be regarded only as a means for choosing the products in relation to the expected economically reasonable working life of the works.

3. Performance of the product and references to the methods used for its assessment

3.1 Mechanical resistance and stability (BWR 1)

Essential characteristic	Performance
Characteristic resistance for tension loads	See Annex C 1
Displacement	See Annex C 1
Point thermal transmittance	See Annex C 2
Plate stiffness	See Annex C 2

3.2 Safety in case of fire (BWR 2)

ETAG 004 is relevant.

3.3 Hygiene, health and environment (BWR 3)

Regarding dangerous substances contained in this European Technical Assessment, there may be requirements applicable to the products falling within its scope (e.g. transposed European legislation and national laws, regulations and administrative provisions). In order to meet the provisions of the Regulation (EU) No 305/2011, these requirements need also to be complied with, when and where they apply.

3.4 Safety in use (BWR 4)

For basic requirement safety in use the same criteria are valid as for Basic Requirement Mechanical resistance and stability.

3.5 Protection against noise (BWR 5)

Not relevant.

3.6 Energy economy and heat retention (BWR 6)

Not relevant.

3.7 Sustainable use of natural resources (BWR 7)

For the sustainable use of natural resources no performance was determined for this product.

3.8 General aspects relating to fitness for use

Durability and serviceability are only ensured if the specifications of intended use according to Annex B 1 are kept.

4. Assessment and verification of constancy of performance (AVCP) system applied with reference to its legal base

According to the Decision 97/463/EC of the European Commission¹, the system of assessment verification of constancy of performance (see Annex V to the Regulation (EU) No 305/2011 given in the following table apply:

Product	Intended use	Use category	System
Plastic anchors for fixing of external thermal insulation composite systems with rendering	For fixing of external thermal insulation composite systems with rendering	A, B, C and D.	2+

5. Technical details necessary for the implementation of the AVCP system, as provided in the applicable EAD

5.1 Tasks of the manufacturer

The manufacturer shall exercise permanent internal control of production. All the elements, requirements and provisions adopted by the manufacturer shall be documented in a systematic manner in the form of written policies and procedures, including records of results performed. This production control system shall insure that the product is in conformity with this European Technical Assessment.

The manufacturer may only use raw materials stated in the technical documentation of this European Technical Assessment.

The factory production control shall be in accordance with the control plan which is a part of the technical documentation of this European Technical Assessment. The control plan is laid down in the context of the factory production control system operated by the manufacturer and deposited at Technical and Test Institute for Construction Prague.² The results of factory production control shall be recorded and evaluated in accordance with the provisions of the control plan.

The manufacturer shall, on the basis of a contract, involve a body which is notified for the tasks referred to in section 4 in the field of anchors in order to undertake the

¹ Official Journal of the European Communities L 198/31 25.7.1997

² The control plan is a confidential part of the documentation of the European Technical Assessment, but not published together with the ETA and only handed over to the approved body involved in the procedure of AVCP.

actions laid down in section 5.2. For this purpose, the control plan referred to in this section and section 5.2 shall be handed over by the manufacturer to the notified body involved.

The manufacturer shall make a declaration of performance, stating that the construction product is in conformity with the provisions of this European Technical Assessment.

5.2 Tasks of the notified bodies

The notified body shall retain the essential points of its actions referred to above and state the results obtained and conclusions drawn in a written report.

The notified certification body involved by the manufacturer shall issue an certificate of constancy of performance of the product stating the conformity with the provisions of this European Technical Assessment.

In cases where the provisions of the European Technical Assessment and its control plan are no longer fulfilled the notified body shall withdraw the certificate of constancy of performance and inform Technický a zkušební ústav stavební Praha, s.p without delay.

Issued in Prague on 29.08.2014



signed by

Ing. Václav Hadrava

Head of the department Technical Assessment Body

BRAVOLL® PTH-X

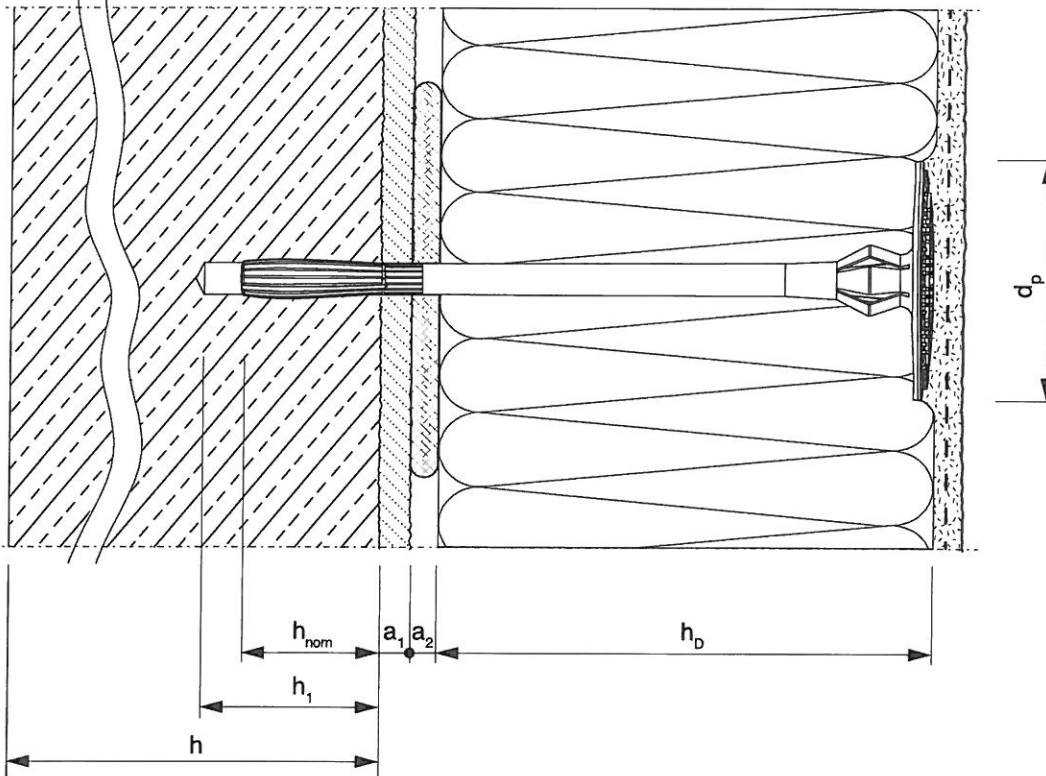

- | | |
|--|---|
| h_{nom} = overall embedment depth | a_2 = thickness of compound and toleration of |
| h_1 = drill hole depth | thickness of equalization layer or non-load |
| h = thickness of base material | bearing coating |
| h_D = thickness of insulation material | d_p = diameter of plate |
| a_1 = thickness of equalization layer and/or | L_a = total length of the anchor |
| non-load bearing coating | |

Determination of total length of the anchor
 $L_a \geq h_D + \min. h_{nom} + \max. a_1 + \max. a_2$

BRAVOLL® PTH-X

Product description
 Installed conditions

Annex A 1

BRAVOLL® PTH-EX

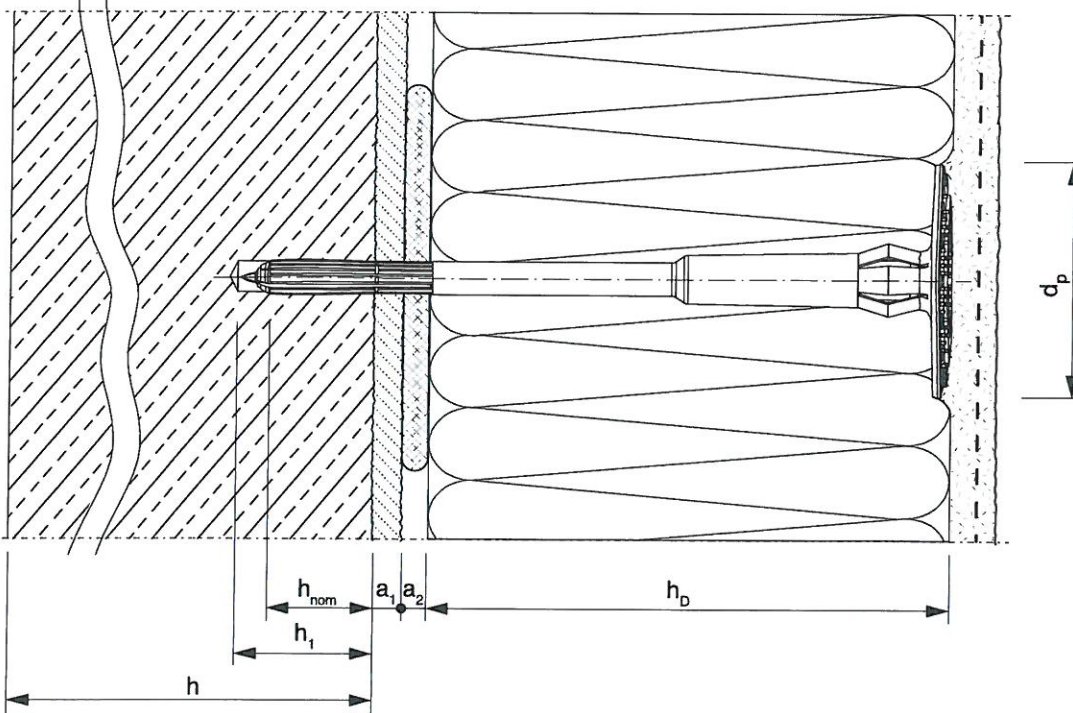

- | | |
|---|---|
| h_{nom} = overall embedment depth | a_2 = thickness of compound and toleration of thickness of equalization layer or non-load bearing coating |
| h_1 = drill hole depth | |
| h = thickness of base material | |
| h_D = thickness of insulation material | d_p = diameter of plate |
| a_1 = thickness of equalization layer and/or non-load bearing coating | L_a = total length of the anchor |

Determination of total length of the anchor
 $L_a \geq h_D + \min. h_{nom} + \max. a_1 + \max. a_2$

BRAVOLL® PTH-EX

Product description
 Installed conditions

Annex A 2

Anchor sleeve and expansion nail

BRAVOLL® PTH-X

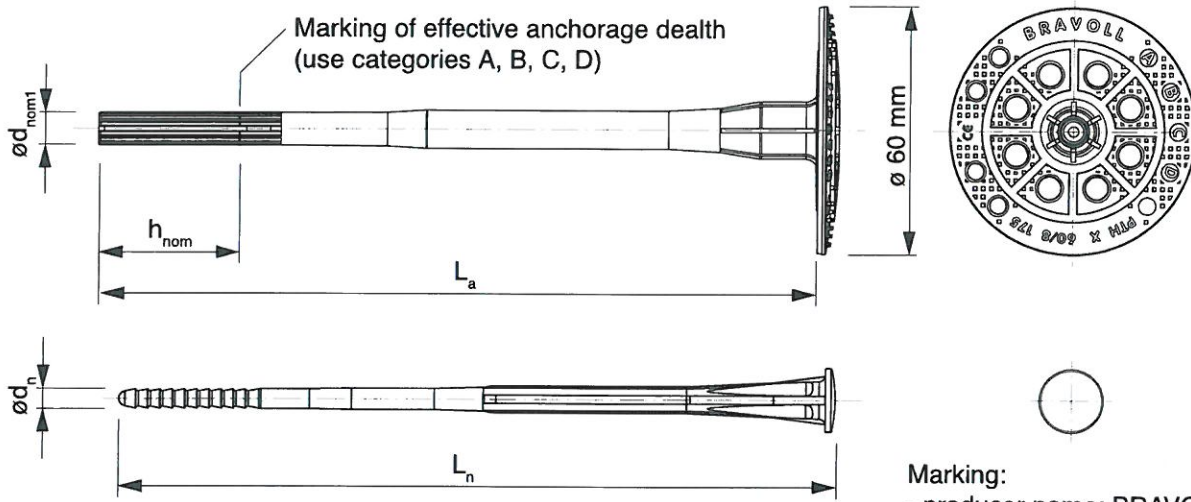

Marking:
 - producer name: BRAVOLL
 - anchor type PTH-X
 - length of anchor (L_a)
 e.g. 175

BRAVOLL® PTH-EX

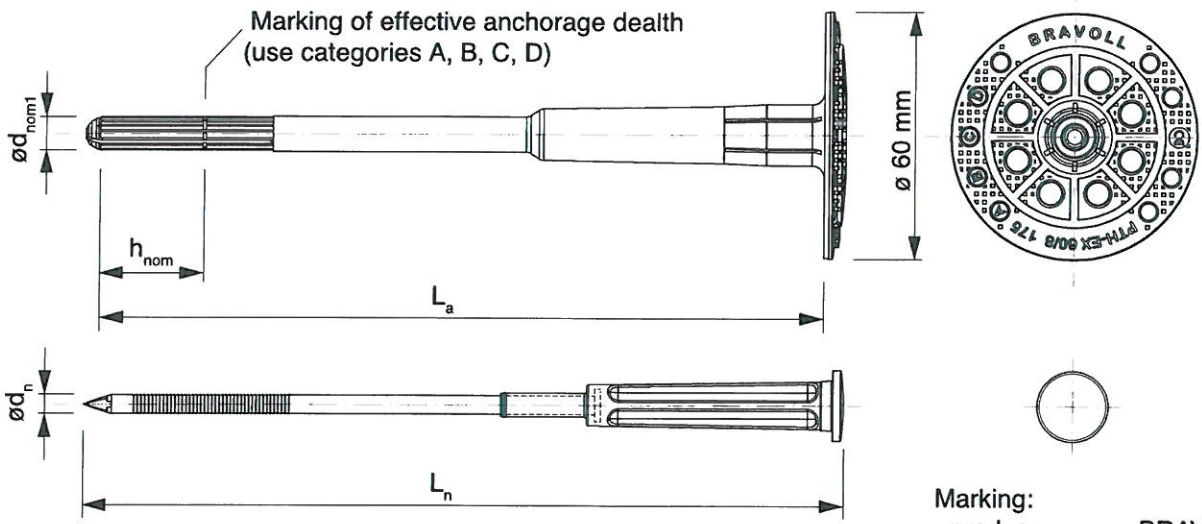

Marking:
 - producer name: BRAVOLL
 - anchor type PTH-EX
 - length of anchor (L_a)
 e.g. 175

BRAVOLL® PTH-X, PTH-EX

Product description

Annex A 3

Table A1: Dimensions

Anchor type	Anchor sleeve			Plate of anchor	Expansion nail
	$\varnothing d_{nom}$ [mm]	h_{nom} [mm]	L_a [mm]	$\varnothing d_p$ [mm]	L_n [mm]
PTH-X	8	35	115-255	60	115-255
PTH-EX	8	25	115-355	60	120-360

Table A2: Materials

Designation	Color	Material
Anchor sleeve PTH-X	natural, yellow	Copolymer polypropylene PP
Expansion nail PTH-X	natural	Reinforced polyamide
Anchor sleeve PTH-EX	orange, brown, yellow, natural, blue	Copolymer polypropylene PP
Expansion nail PTH-EX	nail is color of galvanized and pins head is color natural	Steel strength class 5.8, galvanized $\geq 5\mu\text{m}$ with head of pin has plastic coating
		Stainless steel
Plate IT PTH 100 / IT PTH 140	natural	Reinforced polyamide

BRAVOLL® PTH-X, PTH-EX
Product description
Dimensions
Materials
Annex A 4

BRAVOLL® IT PTH 100

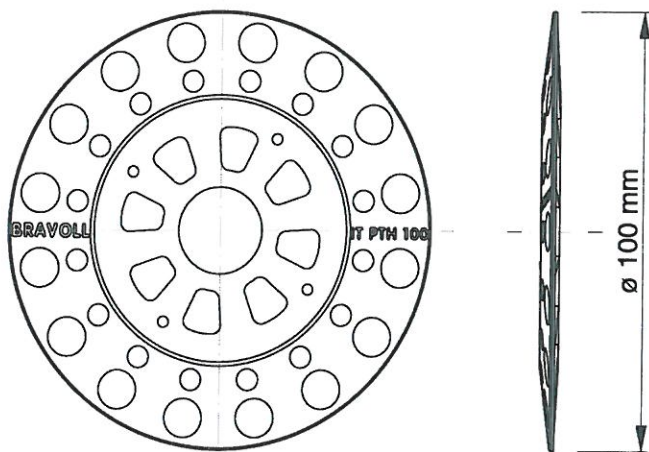

BRAVOLL® IT PTH 140

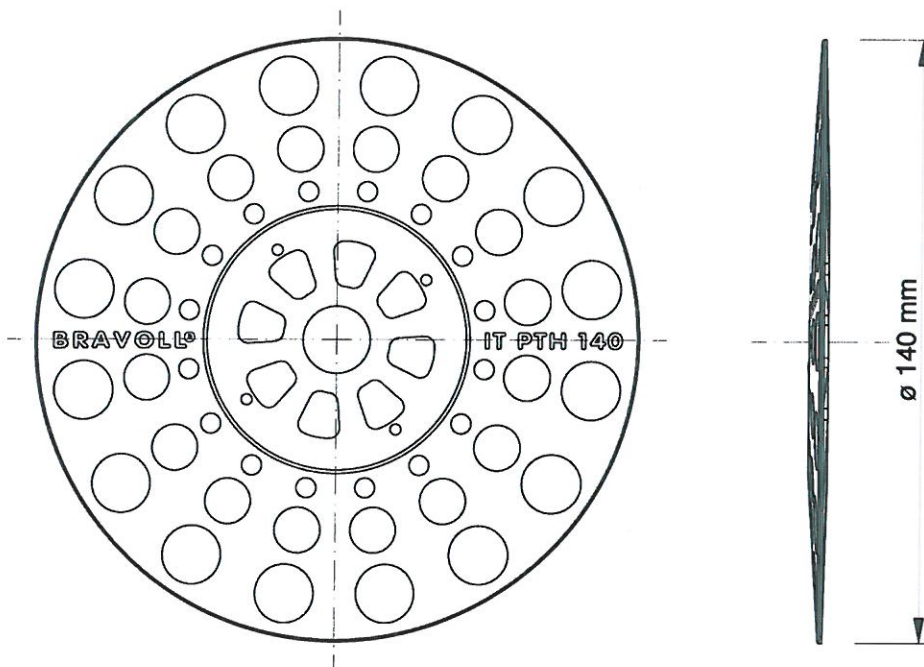

BRAVOLL®
IT PTH 100 and IT PTH 140

Additional plate in combination with BRAVOLL® PTH-EX

Annex A 5

Specifications of intended use

Anchorage subject to:

- Multiple fixing for the anchorage of bonded thermal insulation composite systems (ETICS).

Base materials

- Reinforced or unreinforced normal weight concrete (Use category A), according to Annex B3.
- Solid brick (Use category B), according to Annex B3.
- Calcium silicate solid units (Use category B), according to Annex B3.
- Vertical perforated brick (Use category C), according to Annex B3-B4.
- Vertically perforated clay bricks according to ÖNORM B 6124 (Use category C), according to Annex B3-B4.
- Lightweight aggregate concrete hollow blocks LAC (Hbl) (Use category D), according to Annex B3-B4.
- The characteristic tension resistance of the anchor may be determined by means of job site pull-out tests carried out on the material actually used, if a characteristic resistance of the base material does not exist (for example masonry made of other solid masonry units or made of perforated clay bricks).

Use conditions

- The anchor may only be used for transmission of wind suction loads and shall not be used for the transmission of dead loads of the thermal insulation composite system. The dead loads have to be transmitted by the bonding of the thermal insulation composite system.

Use categories:

- A, B, C and D.

Design:

- The design of anchorages is carried out in compliance with ETAG 014 "Guideline for European Technical Assessment of Plastic Anchors for Fixing of External Thermal Insulation Composite Systems with Rendering" under the responsibility of an engineer experienced in anchorages.
- Verifiable calculation notes and drawings shall be prepared taking account of the loads to be anchored, the nature and strength of the base materials, the thickness of insulation and the dimensions of the anchorage as well as of the relevant tolerances.
- Proof of direct local application of load on the base material shall be delivered. The anchor shall only be used for the transmission of wind suction loads. All other loads such as dead load and restraints shall be transmitted by the adhesion of the relevant external thermal insulation composite system

BRAVOLL® PTH-X, PTH-EX

**Intended use
Specifications**

Annex B 1

Installation:

The fitness for use of the anchor can only be assumed if the following conditions of installation are met:

- Anchor installation carried out by appropriately qualified personnel under the supervision of the person responsible for technical matters on site.
- Use of the anchor only as supplied by the manufacturer without exchanging any component of the anchor.
- Anchor installation in accordance with the manufacturer's specifications and drawings using the tools.
- Checks before placing the anchor, to ensure that the characteristic values of the base material in which the anchor is to be placed, is identical with the values, which the characteristic loads apply for.
- Observation of the drill method (Drill holes in masonry made of perforated clay bricks, vertically perforated clay bricks and lightweight aggregate concrete hollow blocks (LAC) may only be drilled using the rotary drill. Other drilling methods may also be used if job-site tests according to Annex B 5 evaluate the influence of hammer or impact drilling.)
- Placing drill holes without damaging the reinforcement
- Temperature during installation of the anchor $\geq 0^{\circ}\text{C}$.
- Exposure to UV due to solar radiation of the anchor not protected by rendering 6 weeks.

BRAVOLL® PTH-X, PTH-EX

Annex B 2

Intended use
Installation

Types of base materials

Table B1: Base materials

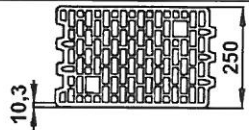
Base material	Use category	Bulk density class [kg/dm ³]	Min. compressive strength β [N/mm ²]	General remarks	Drilling method
Concrete C12/15 according to EN 206-1	A				Hammer drilling
Concrete C16/20 – C50/60 according to EN 206-1	A				Hammer drilling
Solid clay bricks according to EN 771-1	B	$\geq 1,7$	20	Vertically perforation up to 15%	Hammer drilling
Calcium silicate solid units according to EN 771-2	B	$\geq 1,8$	12		Hammer drilling
Vertically perforated clay bricks according to EN 771-1	C	$\geq 0,7$	12	Vertically perforation more than 15% and less than 55%	Only rotary drilling
Vertically perforated clay bricks according to ÖNORM B 6124	C	$\geq 0,9$	10		Only rotary drilling
Lightweight concrete hollow block e.g. according to EN 771-3	D	$\geq 0,5$	4	see Annex B4	Only rotary drilling
Lightweight aggregate concrete hollow blocks LAC (Hbl) according to EN 1520	D	$\geq 1,2$	4		Only rotary drilling

BRAVOLL® PTH-X, PTH-EX

Annex B 3

Intended use
Base materials

Types of base materials

Table B2: Assignment type anchor for lightweight concrete hollow blocks according to EN 771-3 and Solid clay bricks according to EN 771-1 and according to ÖNORM B6124

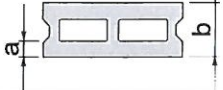
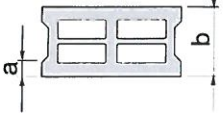
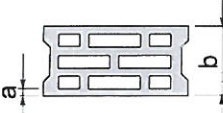
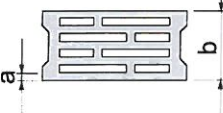
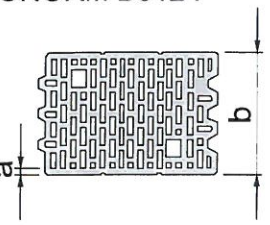
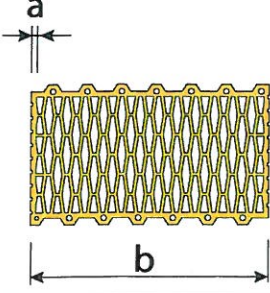
Geometry	Thickness of brick b [mm]	Outer web in longitudinal direction a [mm]	Anchor type PTH-X, PTH-EX
	175	50	●
	240 300	50	●
	175	35	●
	240 300 365	35	●
	240 300 365	30	●
Reference brick ÖNORM B6124 	250	10,3	●
	250	10,1	●

BRAVOLL® PTH-X, PTH-EX

Intended use
Base materials

Annex B 4

Installation

Table B3: Installation characteristics

Anchor types	PTH-X	PTH-EX
Nominal diameter of drill bit d_o [mm]	8	8
Min. diameter of drill bit $d_{cut, min} \geq$ [mm]	8,0	8,0
Max. diameter of drill bit $d_{cut, max} \leq$ [mm]	8,45	8,45
Depth of drill hole $h_1 \geq$ [mm]	45	35
Overall embedment depth $h_{nom} \geq$ [mm]	35	25

Table B4: Minimum thickness of base material, edge distance and anchor spacing

Anchor type	Minimum thickness of base material h [mm]	Minimum spacing s_{min} [mm]	Minimum edge distance c_{min} [mm]
PTH-X, PTH-EX	100	100	100

Scheme of distance and spacing.

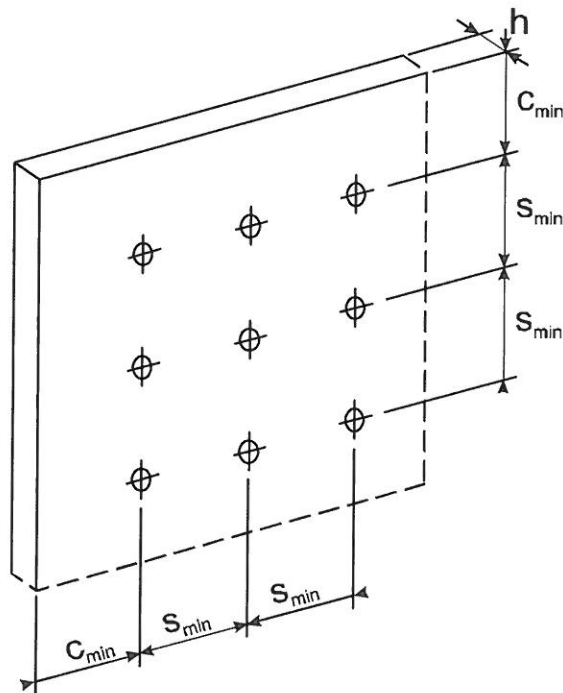

BRAVOLL® PTH-X, PTH-EX

Intended use
Installation characteristics
Edge and axial distances

Annex B 5

Job site tests

The characteristic tension resistance of the anchor may be determined by means of job site pull-out tests carried out on the material actually used, if a characteristic resistance of the base material does not exist (for example masonry made of other solid masonry units or made of perforated clay bricks).

The characteristic resistance of the anchor shall be determined by carrying out at least 15 centric tension load pull-out tests on site. These tests are also possible under the same conditions in a laboratory.

Execution and evaluation of the tests as well as the issue of the test report and the determination of the characteristic resistance should be under the responsibility of approved testing laboratories or the supervision of the person responsible for the execution of the works on site.

Number and position of the anchors to be tested shall be adapted to the relevant special conditions of the site and, for example, to be increased in the case of hidden and larger areas, such that reliable information about the characteristic resistance of the anchor in the base material in question can be derived. The tests shall take into account the most unfavourable conditions of the practical execution.

Assembly

The anchor to be tested shall be installed (e.g. preparation of drill hole drilling tool to be used, drill bit) and the spacing and the edge distances shall be in the same way as planned for the fixing of the external thermal insulation composite system.

Depending on the drilling tool and according to ISO 5468, hard metal hammer-drill bits or hard metal percussion drill bits, respectively, shall be used. The cutting diameter shall be at the upper tolerance limit.

Execution test

The test rig used for the pull-out test shall provide a continuous slow increase of the load, controlled by calibrated load cell. The load shall be applied perpendicularly to the surface of the base material and shall be transmitted to the anchor via an hinge. The reaction force shall be transmitted into the base material at a distance of at least 150 mm from the anchor. The load shall be increased continuously in a way, that the ultimate load is reached after about 1 minute. The load is measured when the ultimate load (N_1) is achieved.

Test report

The test report shall include all information necessary to assess the resistance of the tested anchor. It shall be included in the construction dossier.

The minimum data required are:

- Construction site, owner of building; date and location of the tests, air temperature; type of member (ETICS) to be fixed
- Masonry (type of brick, strength class, all dimensions of bricks, mortar group); visual assessment of masonry (flush joints, joint clearance, regularity)
- Plastic sleeve and special expansion nail, value of the cutting diameter of hard metal hammer-drill bits, measured before and after drilling
- Test rig; results of tests including the indication of value N_1
- Tests carried out or supervised by; signature.

Evaluation of test results

The characteristic resistance N_{Rk1} is derived from the measured values N_1 as follows

$$N_{Rk1} = 0,6 \cdot N_1 \leq 1,5 \text{ kN}$$

N_1 = the mean value of the five smallest measured values at ultimate load

BRAVOLL® PTH-X, PTH-EX

Annex B 6

Intended use
Job site tests

Table C1: Characteristic resistance to tension loads for single anchor

Base material	Use category	Bulk density class [kg/dm ³]	Min. compressive strength β [N/mm ²]	PTH-X [kN]	PTH-EX [kN]
Concrete C 12/15 according to EN 206-1	A			0,6	0,9
Concrete C 16/20 –C50/60 according to EN 206-1	A			0,75	1,2
Solid clay bricks according to EN 771-1	B	$\geq 1,7$	20	0,75	0,9
Calcium silicate solid units according to EN 771-2	B	$\geq 1,8$	12	0,75	0,9
Vertically perforated clay bricks according to EN 771-1	C	$\geq 0,7$	12	0,5	0,6
Vertically perforated clay bricks according to ÖNORM B6124	C	$\geq 0,9$	15	0,4	0,75
Lightweight concrete hollow block e.g. according to EN 771-3	D	$\geq 0,5$	4	0,6	0,75
Lightweight aggregate concrete hollow blocks LAC (Hbl) according to EN 1520	D	$\geq 1,2$	4	0,5	0,6
Partial safety factor	$\gamma_M =$	2,0*			

* in the absence of other national regulations

Table C2: Displacement under tension loads

Assembly Material	PTH-X		PTH-EX	
	Tension load N_{Sk} [kN]	Displacements $\Delta\delta_N$ [mm]	Tension load N_{Sk} [kN]	Displacements $\Delta\delta_N$ [mm]
C12/15 EN 206-1	0,6	0,53	0,3	0,71
C16/20 EN 206-1	0,9	0,59	0,6	0,56
C50/60 EN 206-1	0,75	0,59	0,6	0,56
Solid clay bricks EN 771-1	0,75	0,57	0,3	0,91
Calcium silicate masonry units EN 771-2	0,75	0,51	0,3	0,54
Vertically perforated clay bricks ÖNORM B6124	0,4	0,27	0,25	0,51
Perforated clay bricks POROTHERM P+D 44 EN 771-1	0,5	0,39	0,3	0,49
Lightweight concrete hollow blocks EN 771-3	0,6	0,43	0,25	0,59
Lightweight aggregate concrete EN 1520 (LAC)	0,5	0,42	0,16	0,32

BRAVOLL® PTH-X, PTH-EX**Performances**

Characteristic tension load
Displacement under tension load

Annex C 1

Table C3: Point thermal transmittance

Anchor type	Insulation thickness h_D [mm]	Point thermal transmittance χ [W/K]
PTH-X	80-220	0,000
PTH-EX	90-330	0,001

The thermal bridge effect of the anchor PTH-X is smaller than 0,0005 W/K and can therefore be neglected in the calculation.

Table C4: Plate stiffness

Anchor type	Diameter of the anchor plate [mm]	Load resistance of the anchor plate [kN]	Plate stiffness [kN/mm]
PTH-X	60	1,50	0,6
PTH-EX	60	1,40	0,6

BRAVOLL® PTH-X, PTH-EX

Performances
Point thermal transmittance
Plate stiffness

Annex C 2